

機械加工寸法差 MACHINING TOLERANCE	
呼び寸法区分	寸法差 中級
1以上 4以下	±0.1
4をこえ16 "	±0.2
16 " 63 "	±0.3
63 " 250 "	±0.5
250 "1000 "	±0.8

25 / (√ 6.3 /)

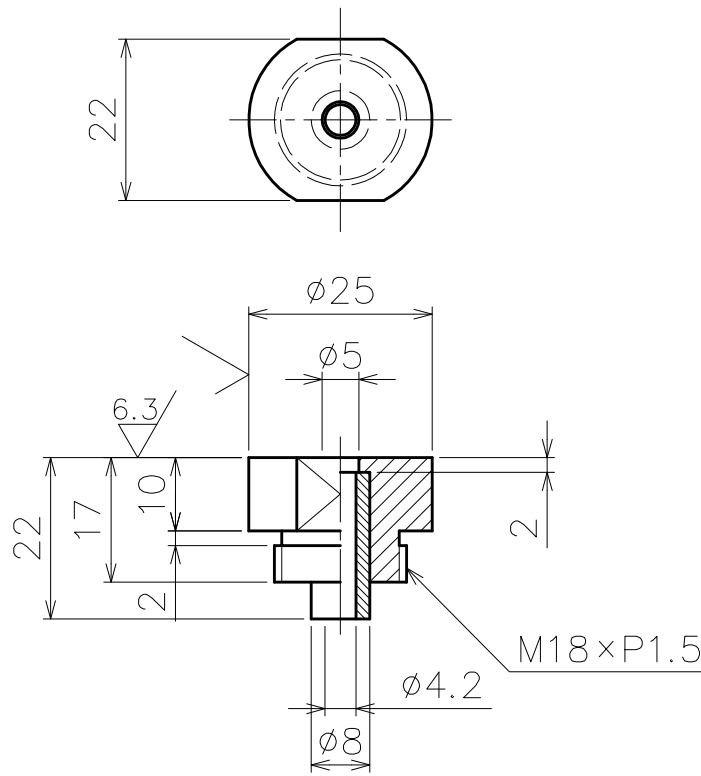

記 1、各稜系面取りの事

2		1	Si ₃ N ₄	φ8×φ4.2×20		
1		1	CrCu	φ25×20		
項 ITEM	品 名 PART NAME		個 数 Q'TY	材 質 MAT'L	寸 法 / 部品番号 SIZE/PARTS No.	記 事 REMARKS
承認 APPROVED	承認 APPROVED	設計 DESIGNED	製図 DRAWN	尺 度 SCALE	1:1	PB-CS4-2522
				個 数 Q'TY		Lower Electrode with Ceramics Sleeve
				日 付 DATE	2014.8.01	図番 DRAW'G No. / 部品番号 PARTS No. SY-0305-01
SAITAMA YOZAI CO.,LTD.						